

widok od wewnątrz skala 1:10

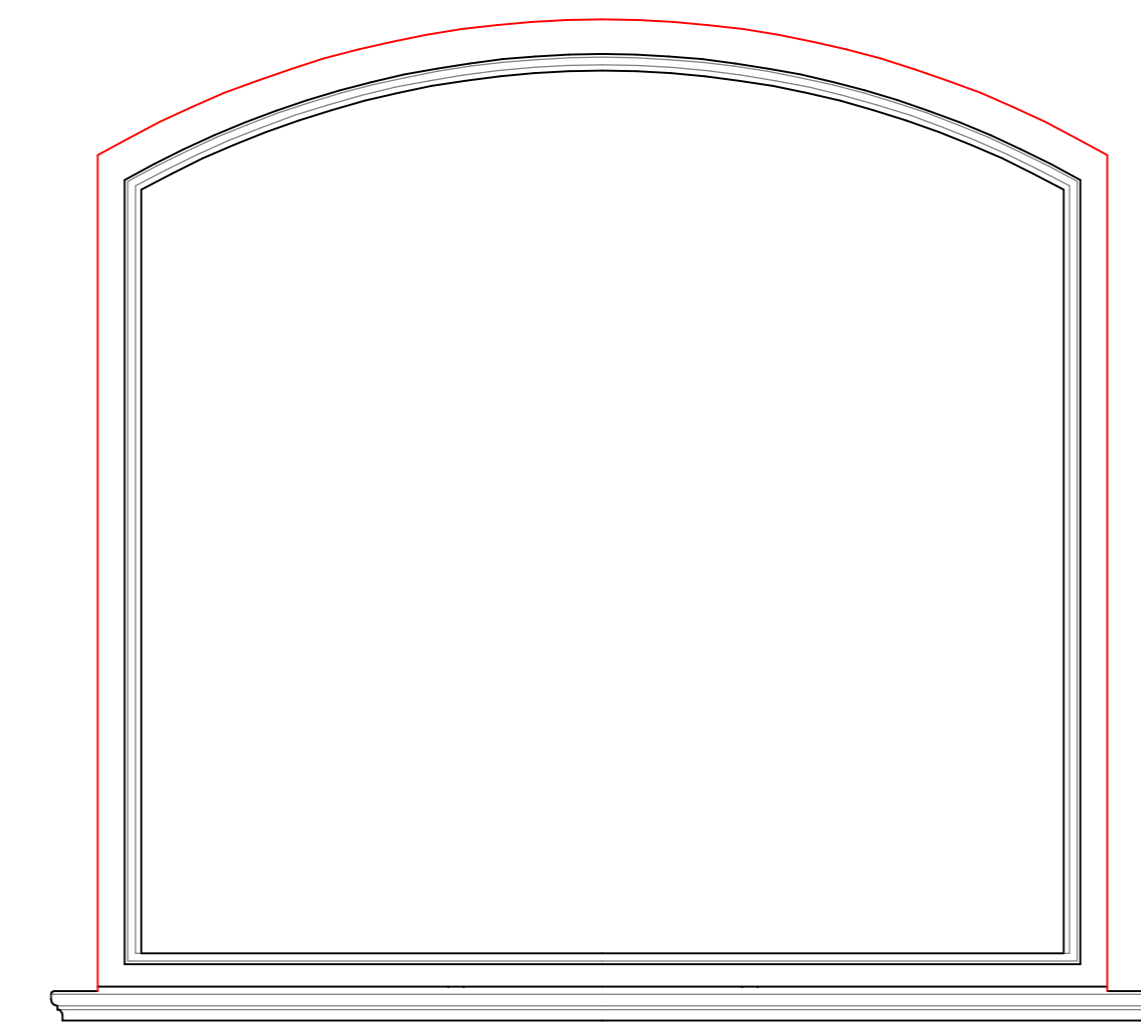

widok oboknia od wewnątrz skala 1:10

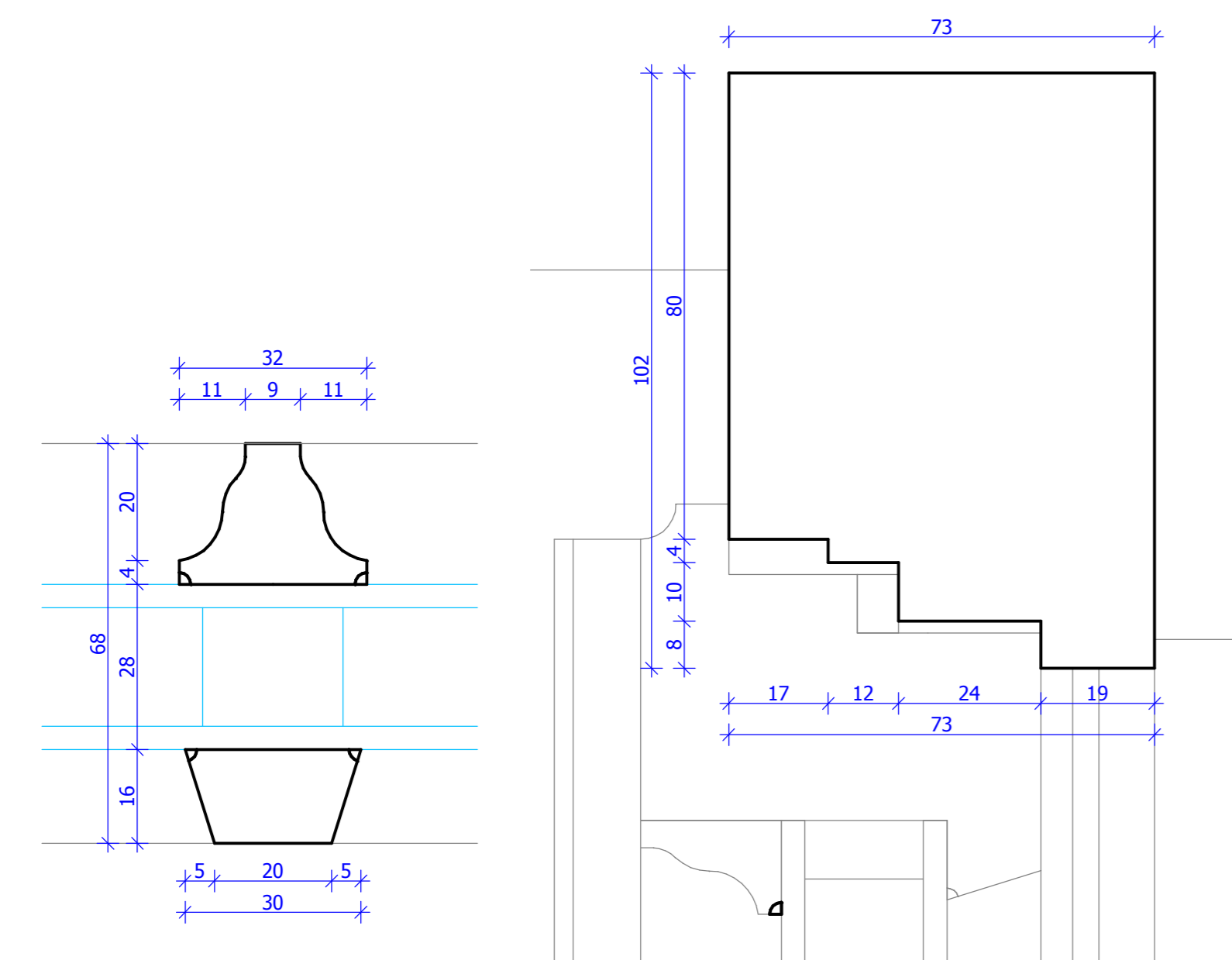
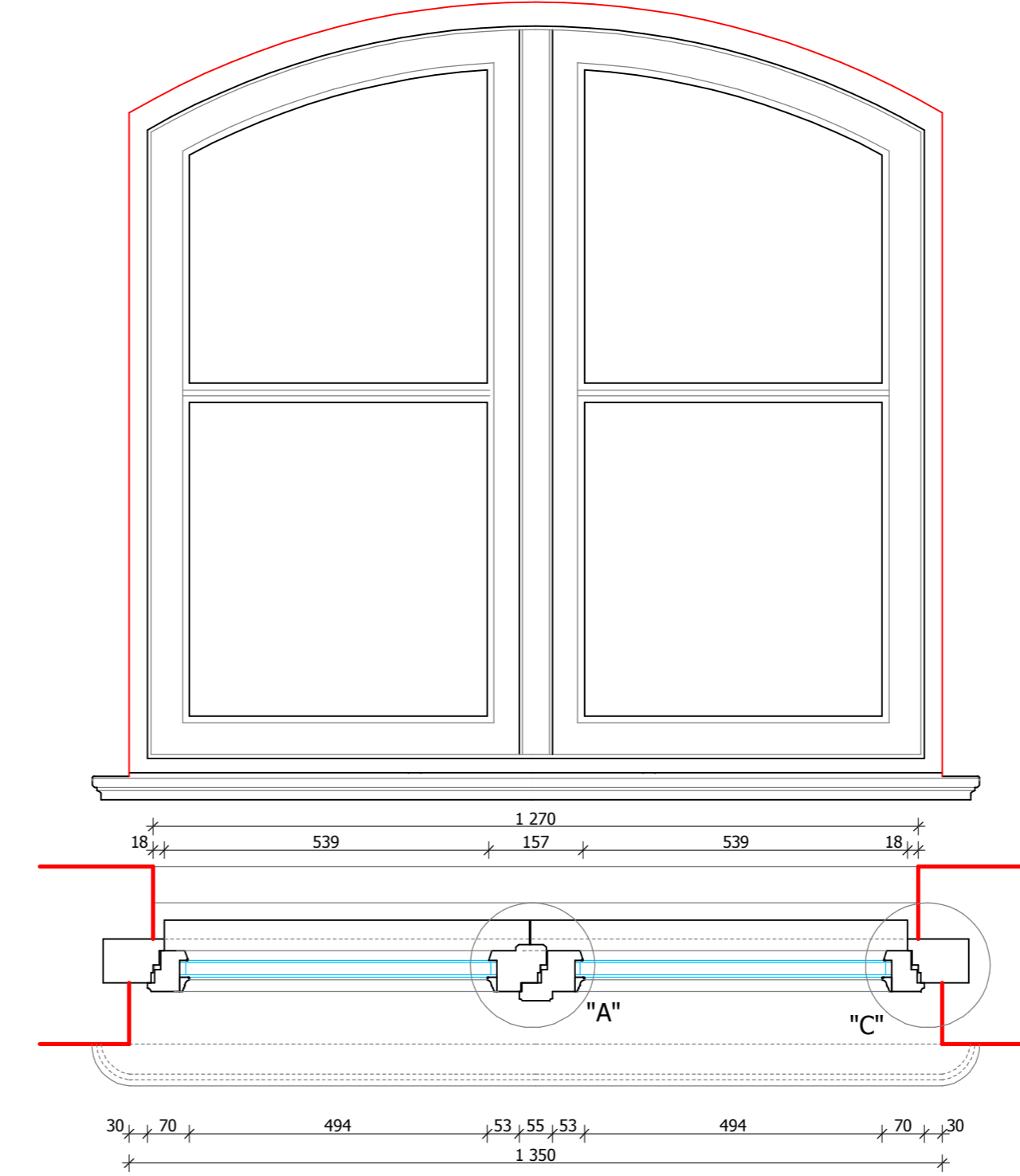

przekrój poziomy

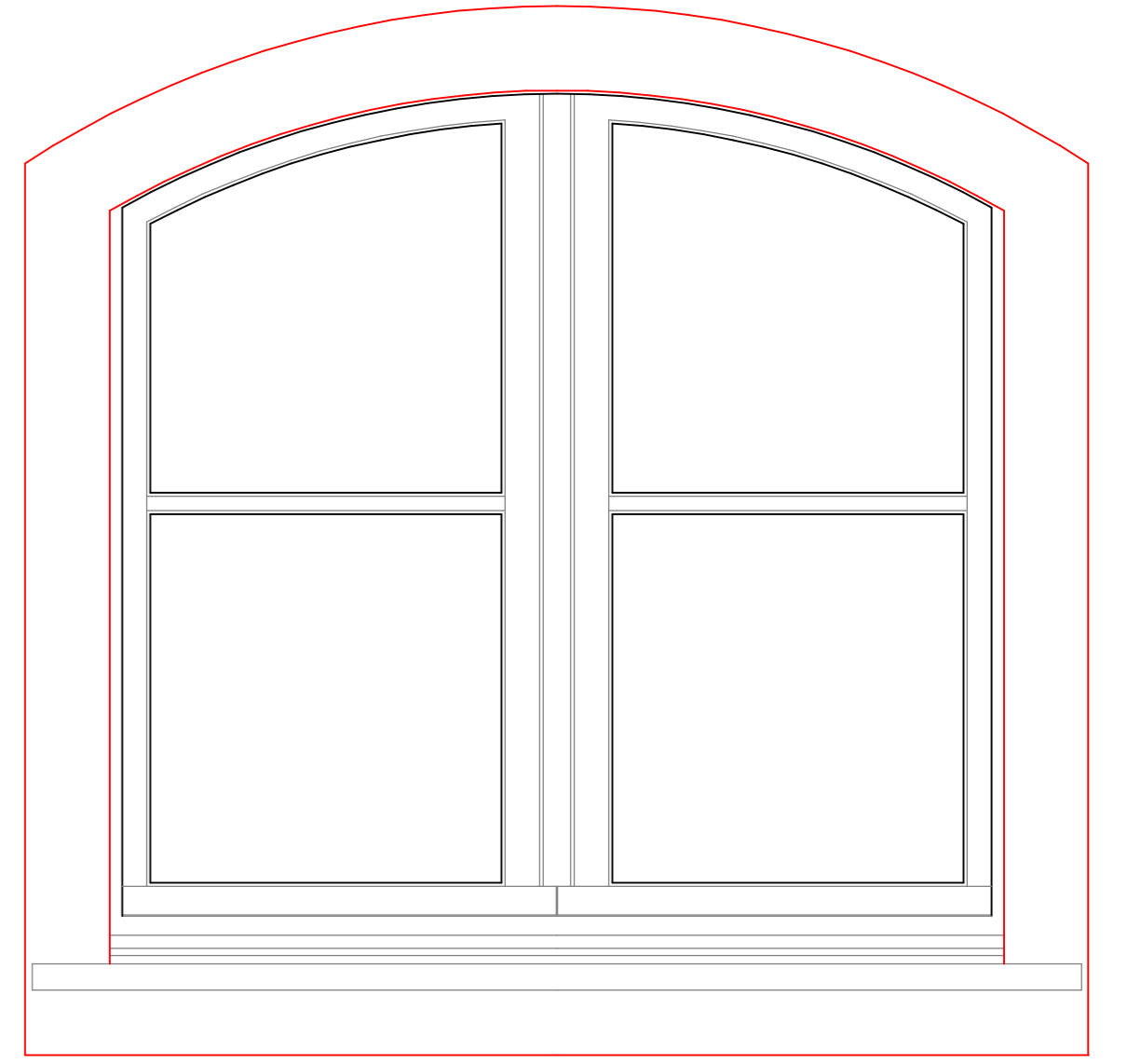
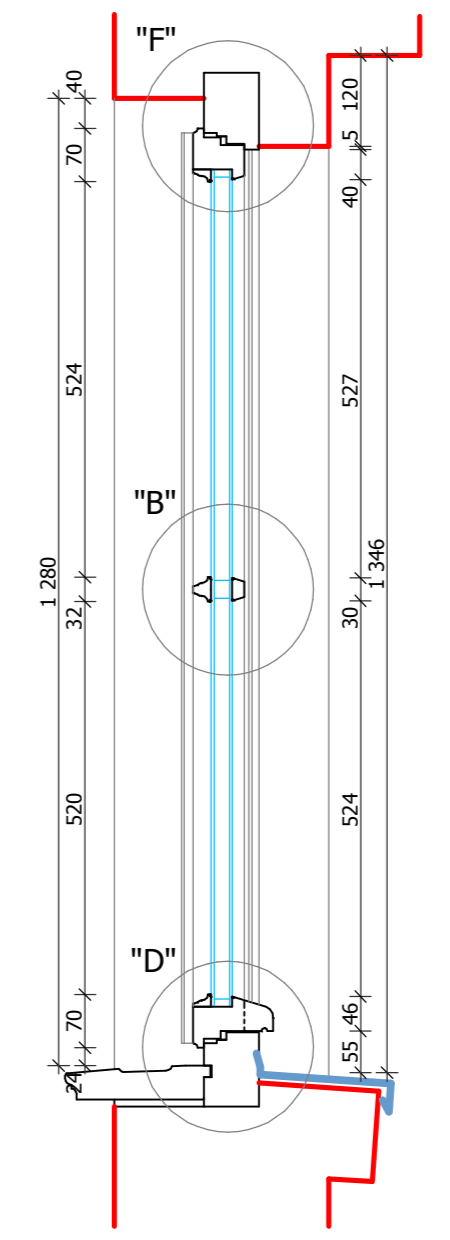

widok z zewnątrz skala 1:10

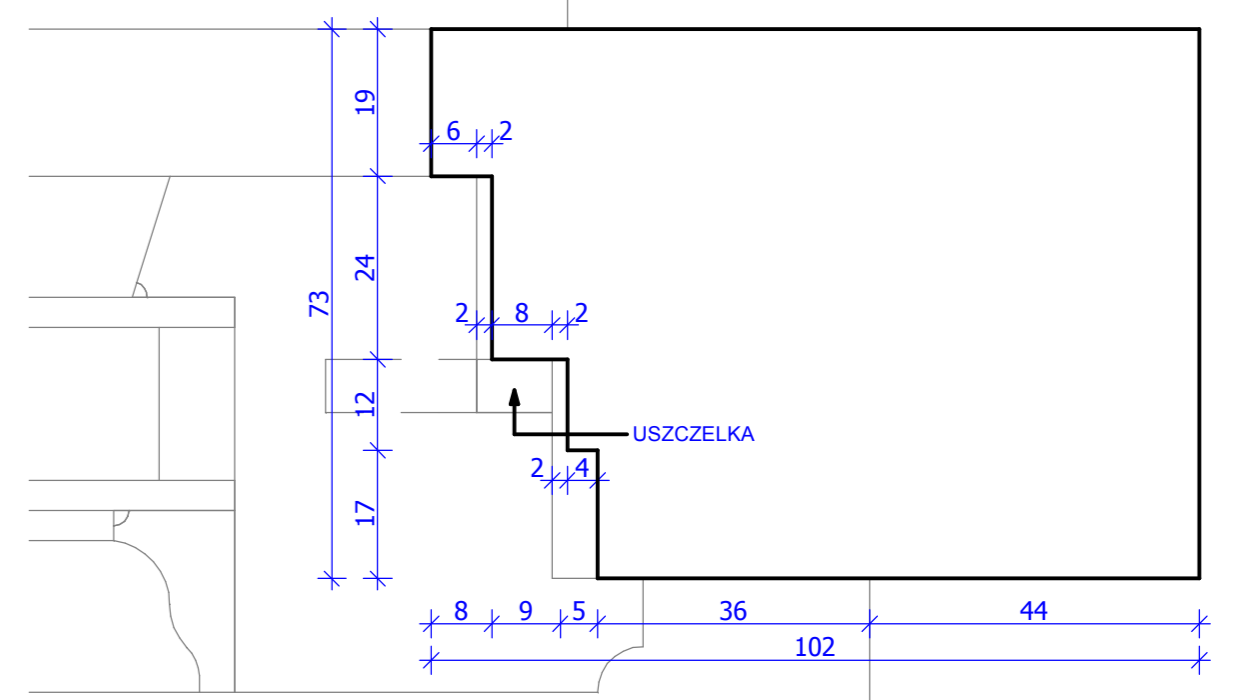
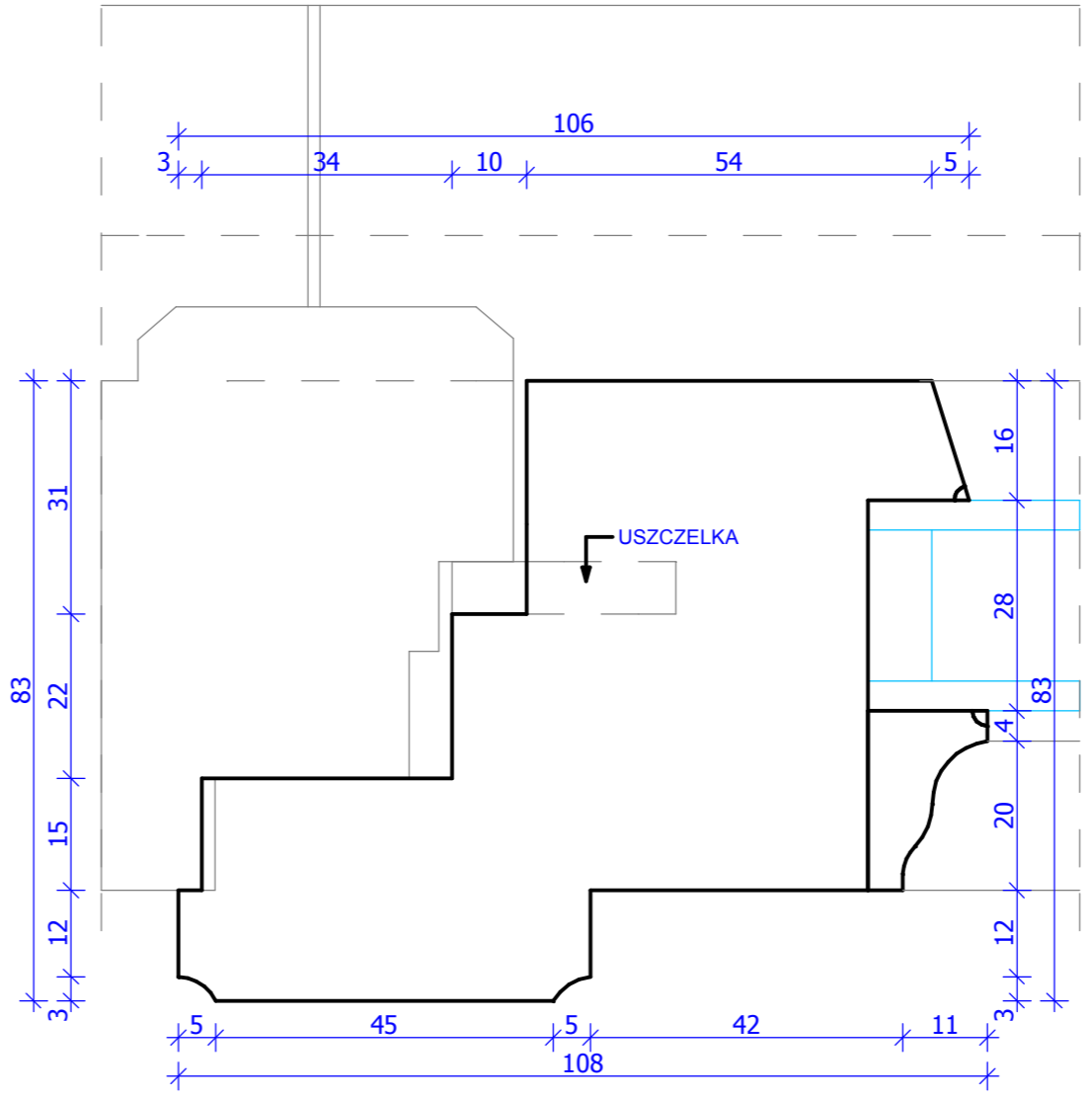
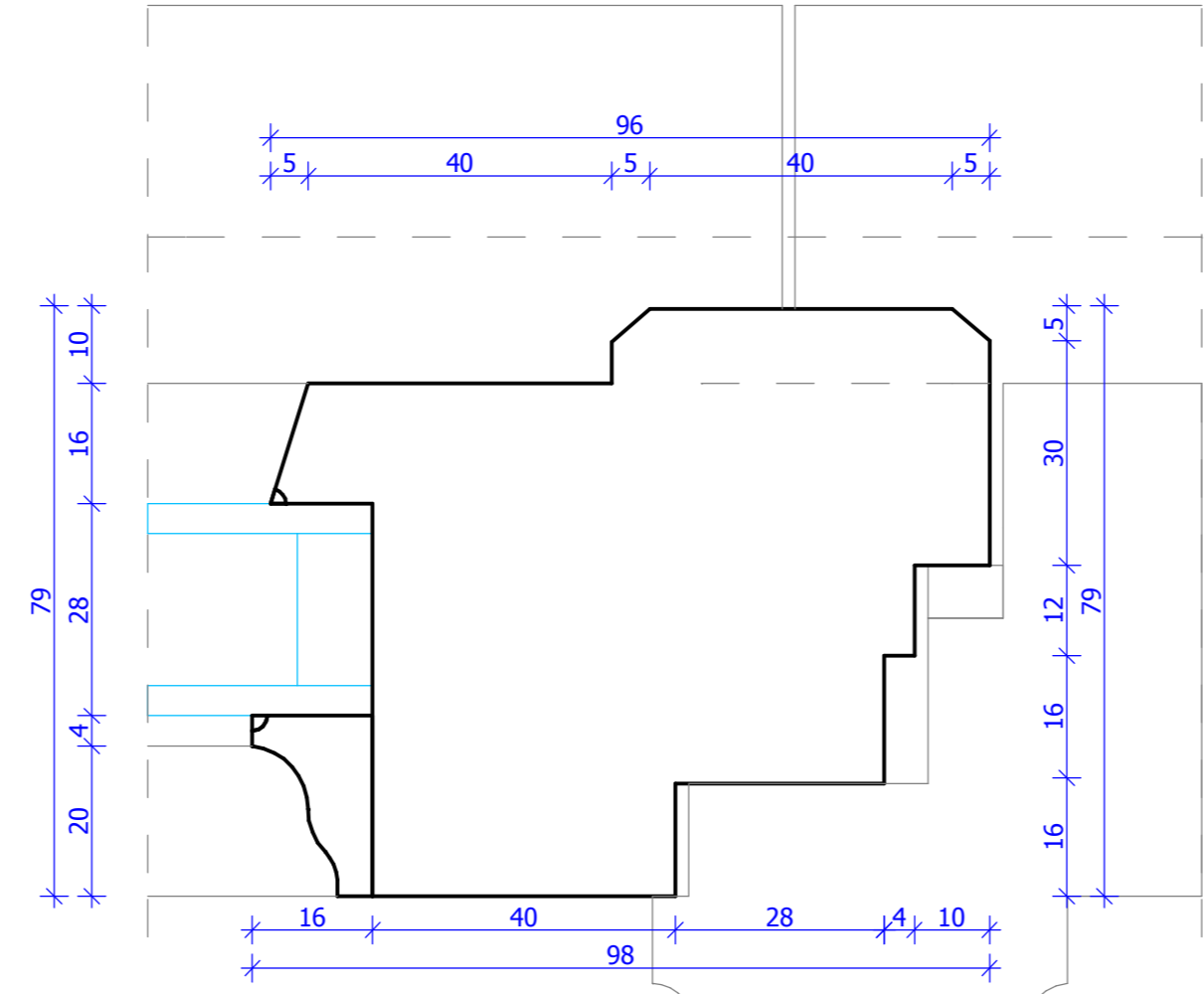
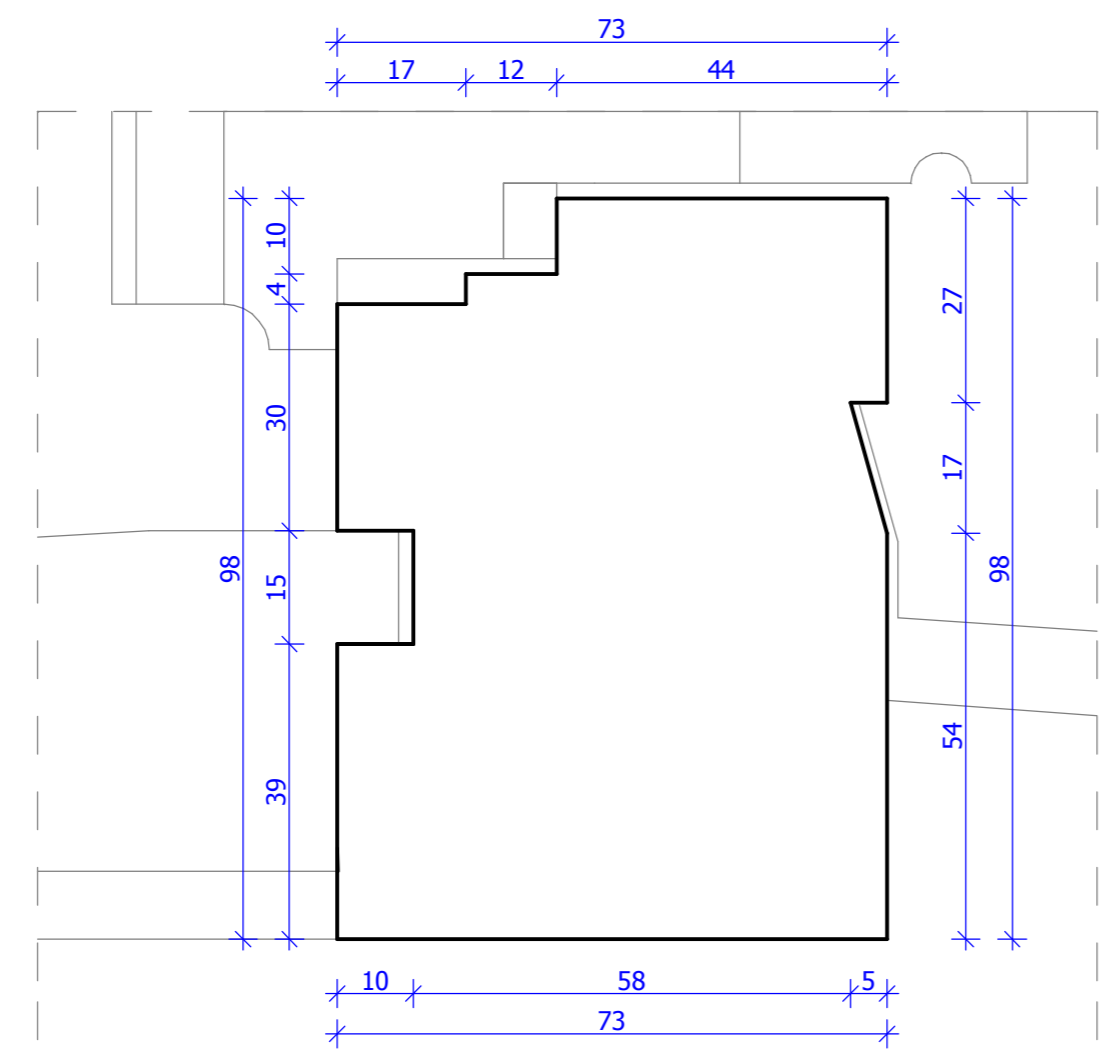
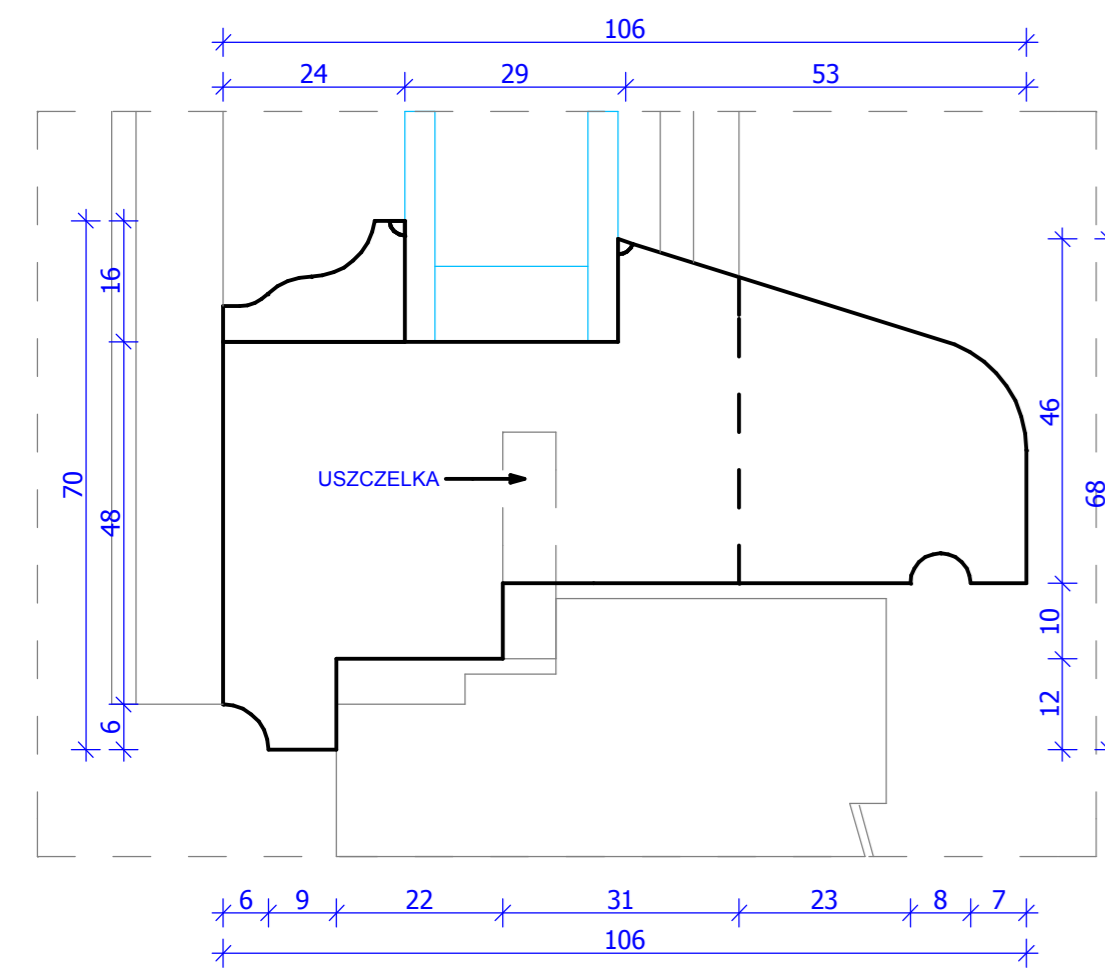

10-718 Olsztyn ul. Janiny Wengris 30, tel. (0-89) 522 66 62, 0 604 560 516		DATA:
STADIUM	PROJEKT WYKONAWCZY	VII 2011
BRANŻA	ARCHITEKTURA	SKALA:
TEMAT:	Wymiana stolarki okiennej Olsztyn - Kortowo ul. Plac Łódzki 2	1:1/1:10
RYSunEK:	Projektowane okno O5	NR RYS.:
PROJEKTOWAŁ:	arch. Maciej Deja	NR UPRAWNIENI:
	arch. Tomasz Zabiński	UPR. bud. nr 74/81/OL
SPRAWDZIŁ:	arch. Anita Świąt-Tekiełska	UPR. bud. nr 9/WMOKK/2007
		19