

detal "A" skala 1:1

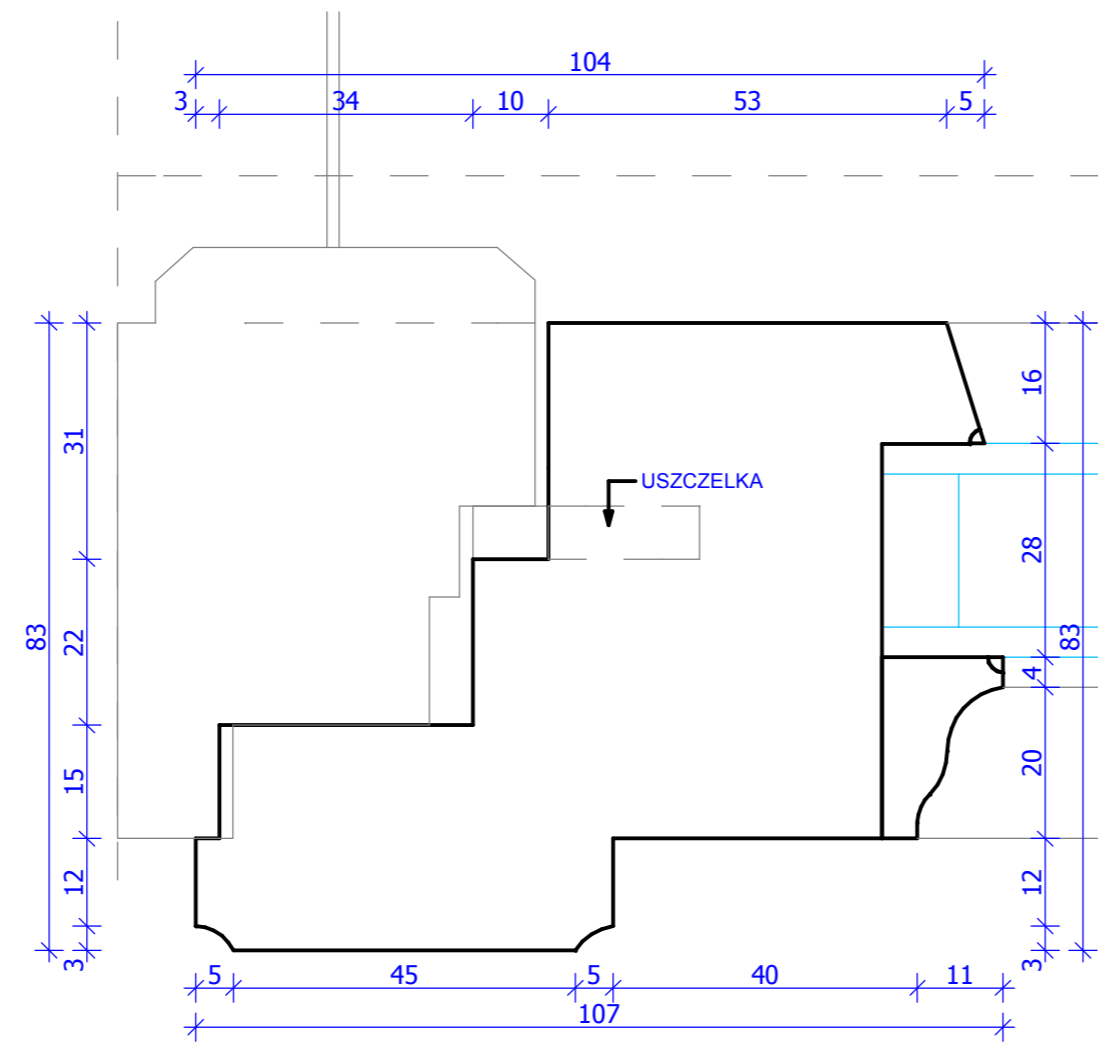

widok wew. oboknia od skala 1:10

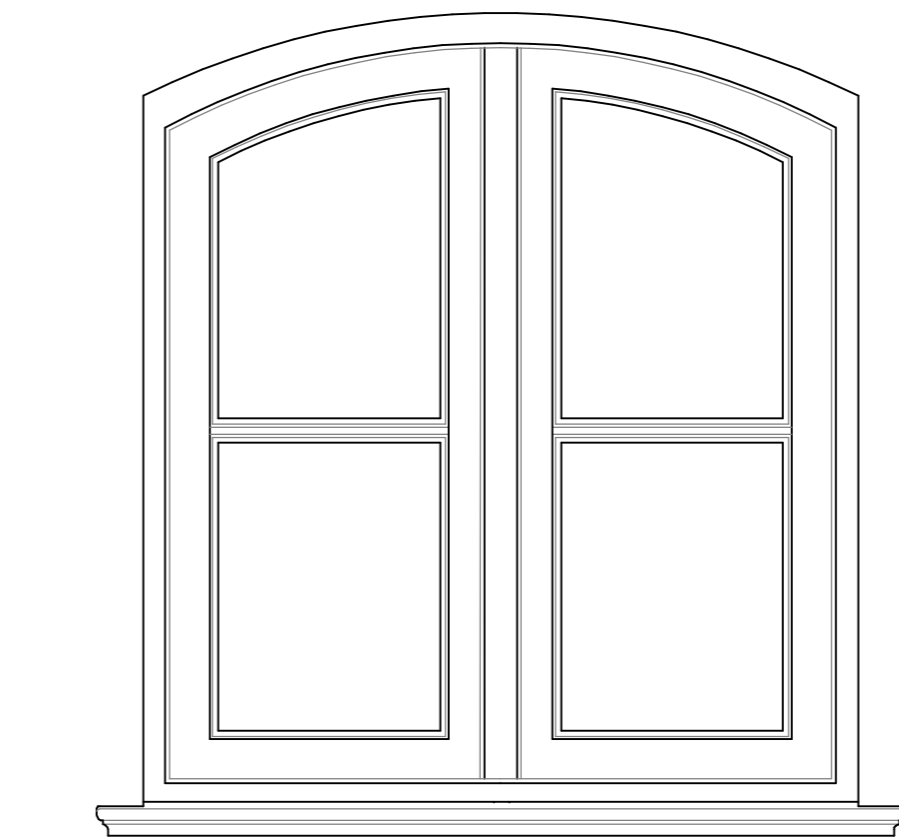

przekrój poziomy

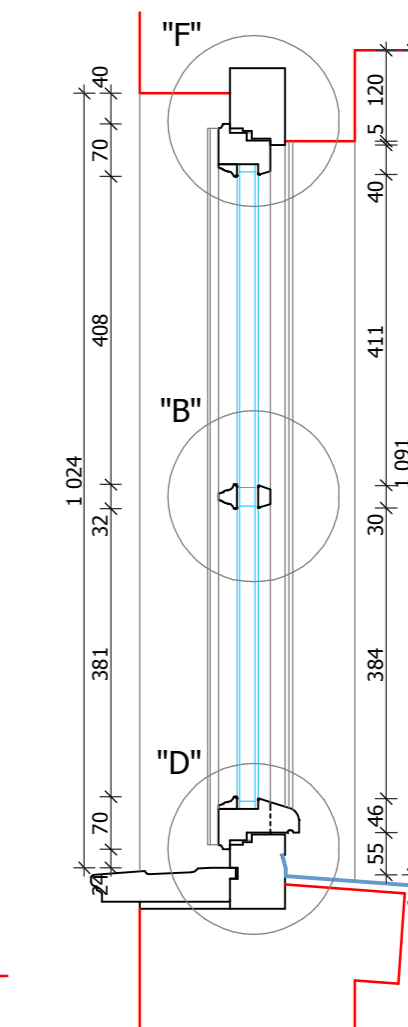

przekrój pionowy

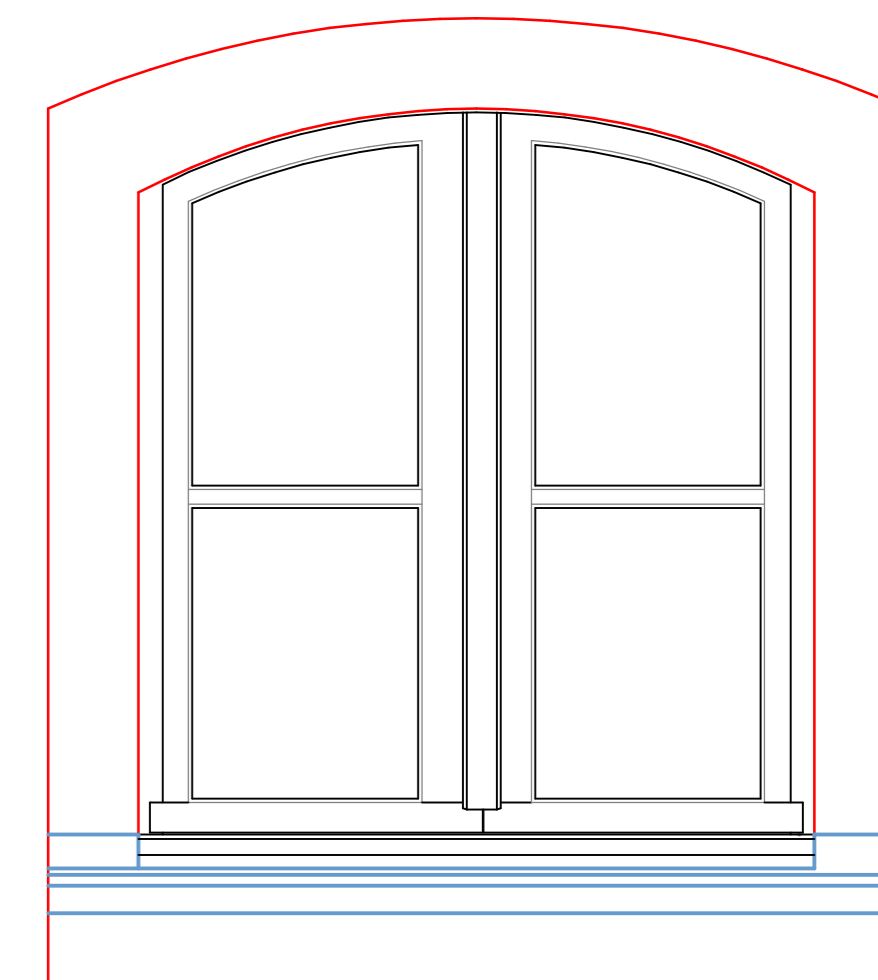

widok z zewnątrz skala 1:10

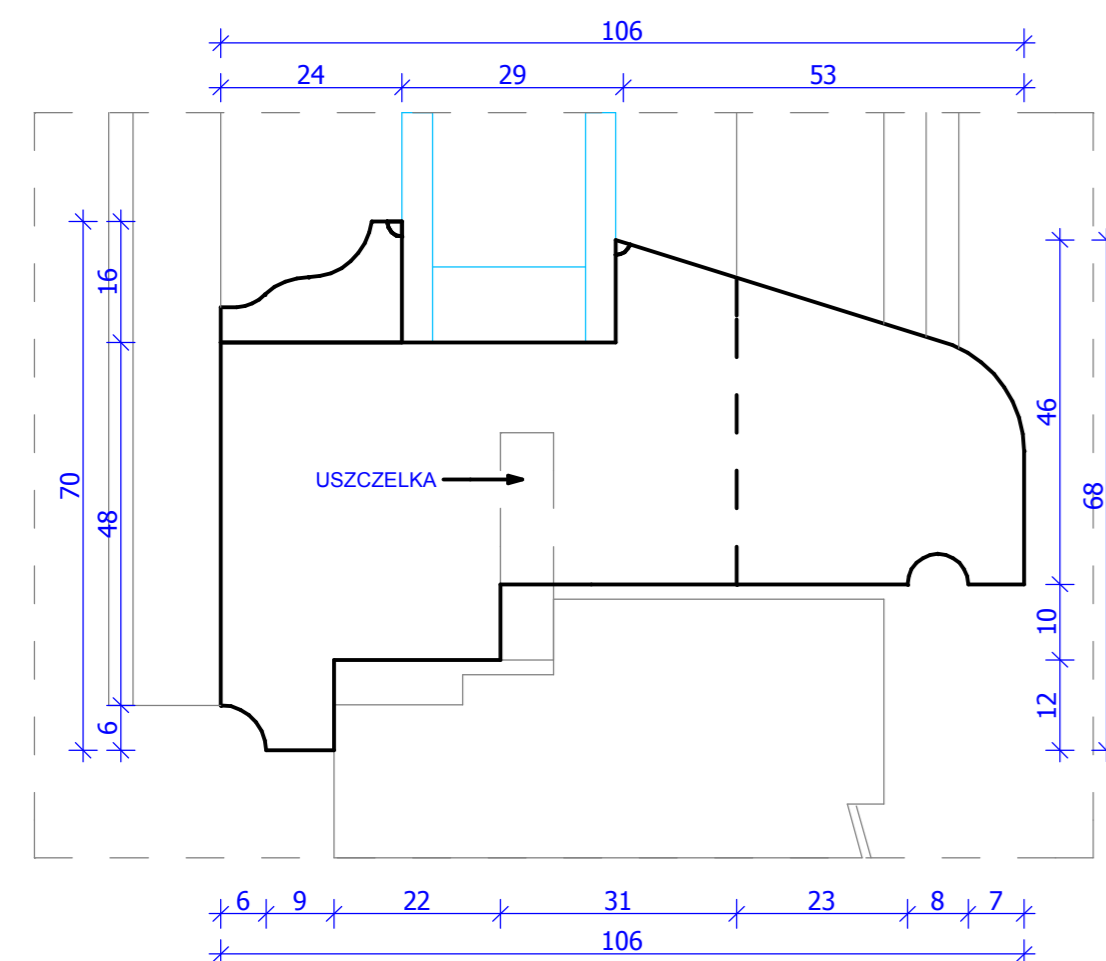

detal "D" skala 1:1

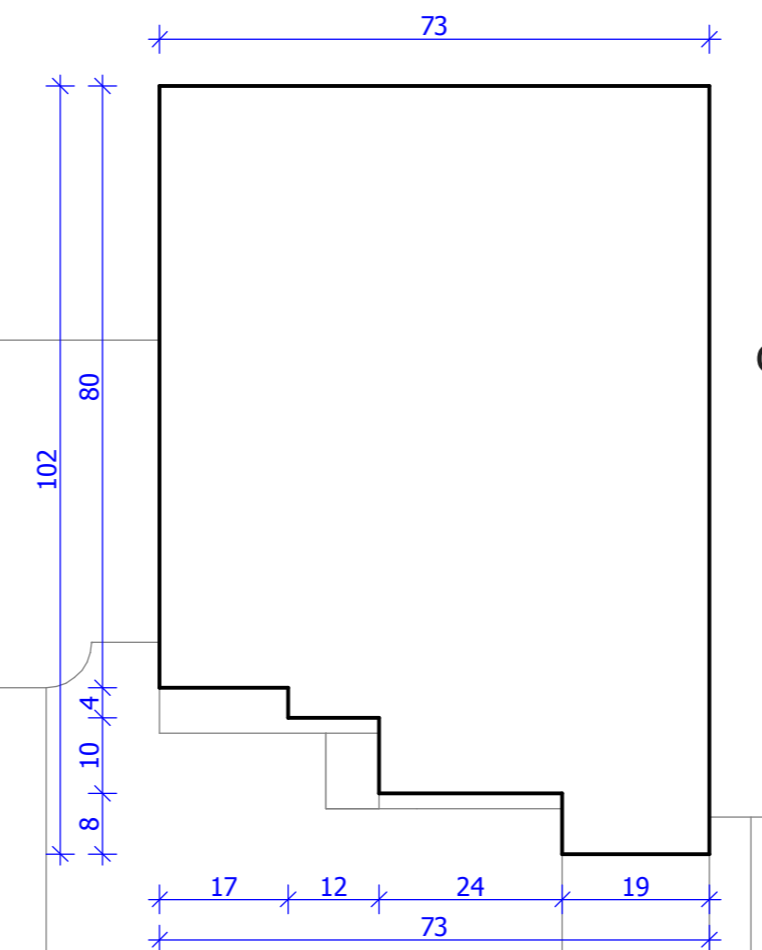
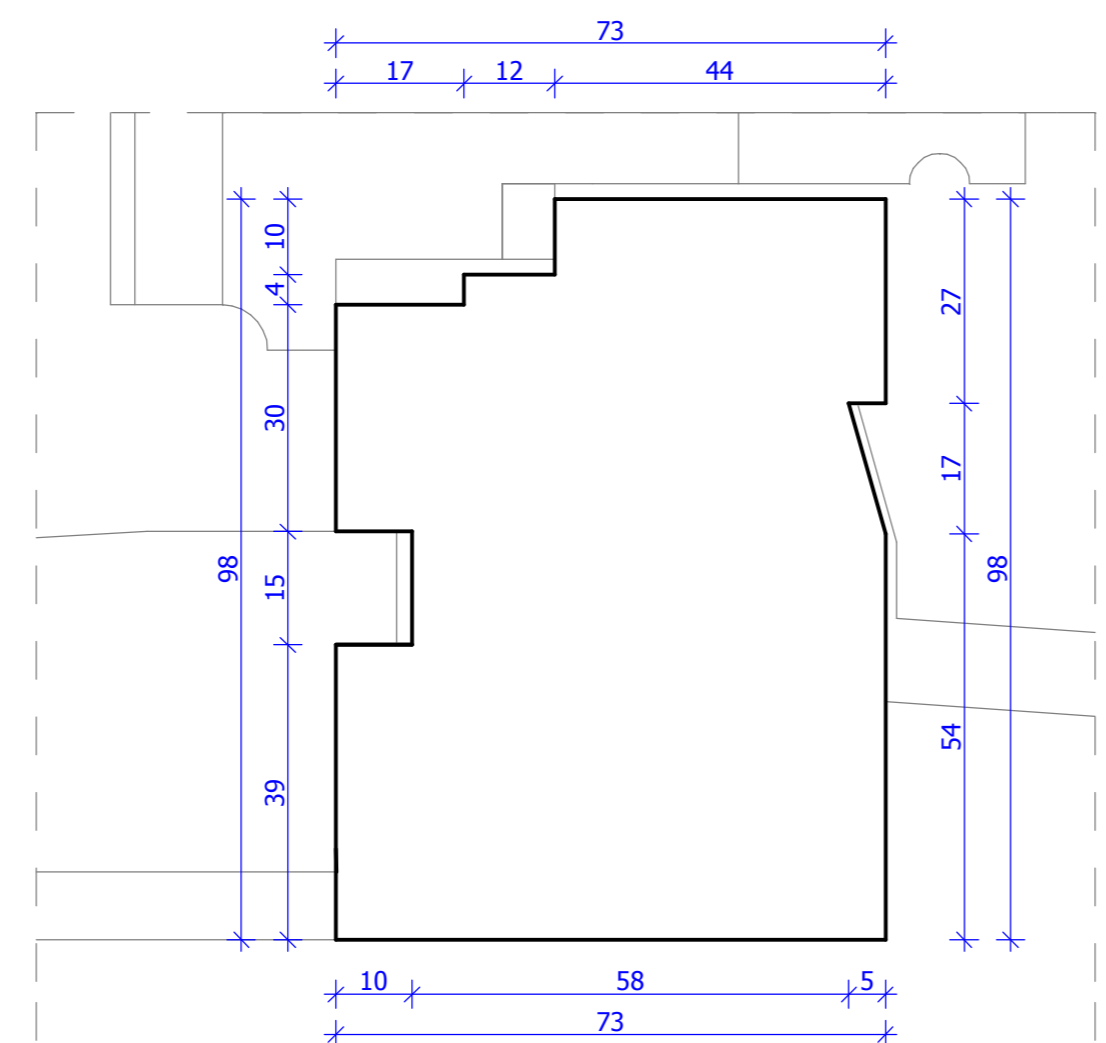

detal "F" skala 1:1

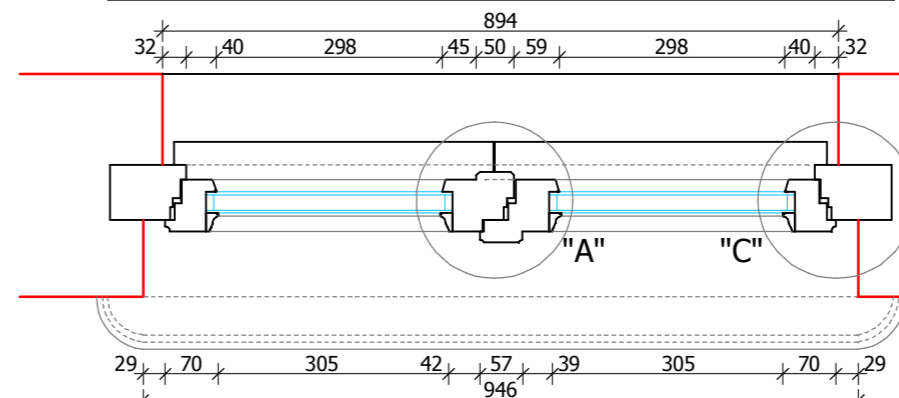

przekrój pionowy

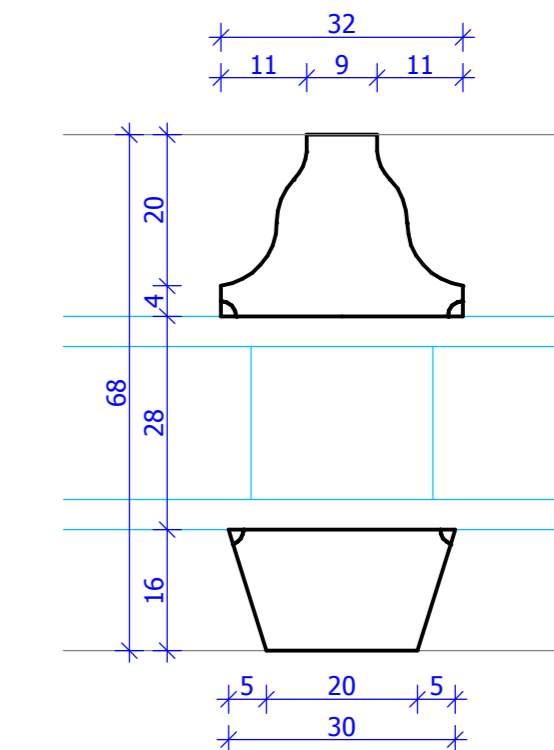

detal "B" skala 1:1



BIURO OBSŁUGI BUDOWNICTWA

10-718 Olsztyn ul. Janiny Wengris 30, tel. (0-89) 522 66 62, 0 604 560 516

| | | |
|-----------------------------|--|-----------------------|
| STADIUM | PROJEKT WYKONAWCZY | DATA: |
| BRANŻA | ARCHITEKTURA | VII 2011 |
| TEMAT: | Wymiana stolarki okiennej Olsztyn - Kortowo ul. Plac Łódzki 2 | SKALA: 1:1/1:10 |
| RYSUNEK: | Projektowane okno O3 | NR RYS.: 15 |
| PROJEKTOWAŁ: | NR UPRAWNIENI: | PODPIS: |
| arch. Maciej Deja | upr. bud. nr 74/81/OL | |
| arch. Tomasz Zabiński | | |
| SPRAWDZIŁ: | NR UPRAWNIENI: | PODPIS: |
| arch. Anita Świat-Tekielska | upr. bud. nr 9/WMOKK/2007 | |